

SUTTON 3LT PENDANT INSTALLATION INSTRUCTIONS

These instructions are provided for your safety.

Please read carefully before commencing work and retain for future reference.

SAFETY INFORMATION

- * It is recommended that a qualified electrician is used to install this product.
- * If you are in any doubt consult a person competent to give advice on the installation of electrical equipment.
- * This fitting should be fitted in accordance with IEE Wiring Regulations and the Building Regulations
- * To prevent electrocution switch off at the mains supply before installing or maintaining this fitting. Ensure other persons cannot restore the electricity supply without your knowledge.
- * To avoid damage to concealed wiring during installation, establish the direction of the supply cable before drilling fixing holes.
- * This fitting is Class 2= and should be fitted to a lighting supply protected by a 5 amp fuse or equivalent circuit breaker.
- * When changing the bulb, always switch off at the mains and allow the old bulb to cool down before handling. Dispose of used bulbs carefully.
- * Place this product out of direct sunlight.

INSTALLATION

1. Ensure the house electricity supply is off at the fuse board.
2. Before removing the existing fitting, carefully note the position of each set of cables. If there are loop in cables that are not connected to the light these must be terminated in a separate terminal block not connected to the fitting.
3. Remove mounting bracket from fitting by removing the two screws located on either side of the ceiling cup. Using the bracket as a template, mark and then drill the fixing holes in the ceiling. Ensure that the holes are drilled into a joist or other suitable mounting and not just the plaster.
4. Chain links may be adjusted to reduce the height of the fitting. Using two pairs of pliers, carefully open the chain links and remove the required number to achieve the desired fitting height. Note: Cloth should be used between the jaws of the pliers to protect the decorative finish. Pull any excess cable through the ceiling cup. **IMPORTANT** ensure the chain is supporting the weight of the fitting and not the electrical cable.
5. Connect the shade to the pendant assembly: The three metal arm braces on the pendant section need to align with the three holes in the top of the pendant shade ① Once the fixing holes are aligned, insert the three thumb screws through the holes in the lamp holder section and into the pendant shade and fully tighten to secure.
6. Attach the bottom adjustable chain link to the last link of the support chain to the connection ring of the chandelier. The link is opened by twisting the barrel nut at the side anti-clockwise, hooking the chain link over the top ring of the chandelier and retightening to close the link ②
7. Carefully insert the glass rods, one by one through the holes in the top and bottom of the shade frame ③
8. Fix the mounting bracket to ceiling using suitable fixings ④ **Take care not to damage wiring.**
9. Use a screwdriver to lever open the connector block housing and feed supply cable through the rubber sleeve. Whilst supporting the weight of the fitting, make electrical connections as follows:⑤
 - Connect the supply live (normally brown or red) to fitting live (marked “L”) on the terminal block.
 - Connect the supply neutral (normally blue or black) to fitting neutral (marked “N”) on the terminal block.

Please note: No earth should be fitted to any part of this light if any earth wires are present please ensure that these are terminated into a separate terminal block (not supplied) to ensure that continuity of the earth for the rest of the house is maintained.

LAURA ASHLEY

IL4788

10. Attach the fitting to the mounting bracket using the retaining screws removed earlier. **Take care not to trap wires in the process** ⑥
11. Fit the bulb: Type and wattage as indicated on the fitting. **The wattage indicated must not be exceeded** ⑦
Note: The main vertical lamp holder stem has an in-line adjustable knuckle joint. This can be used to centralise the lamp holders inside the shade.
12. Switch on the electricity supply at the fuse board.

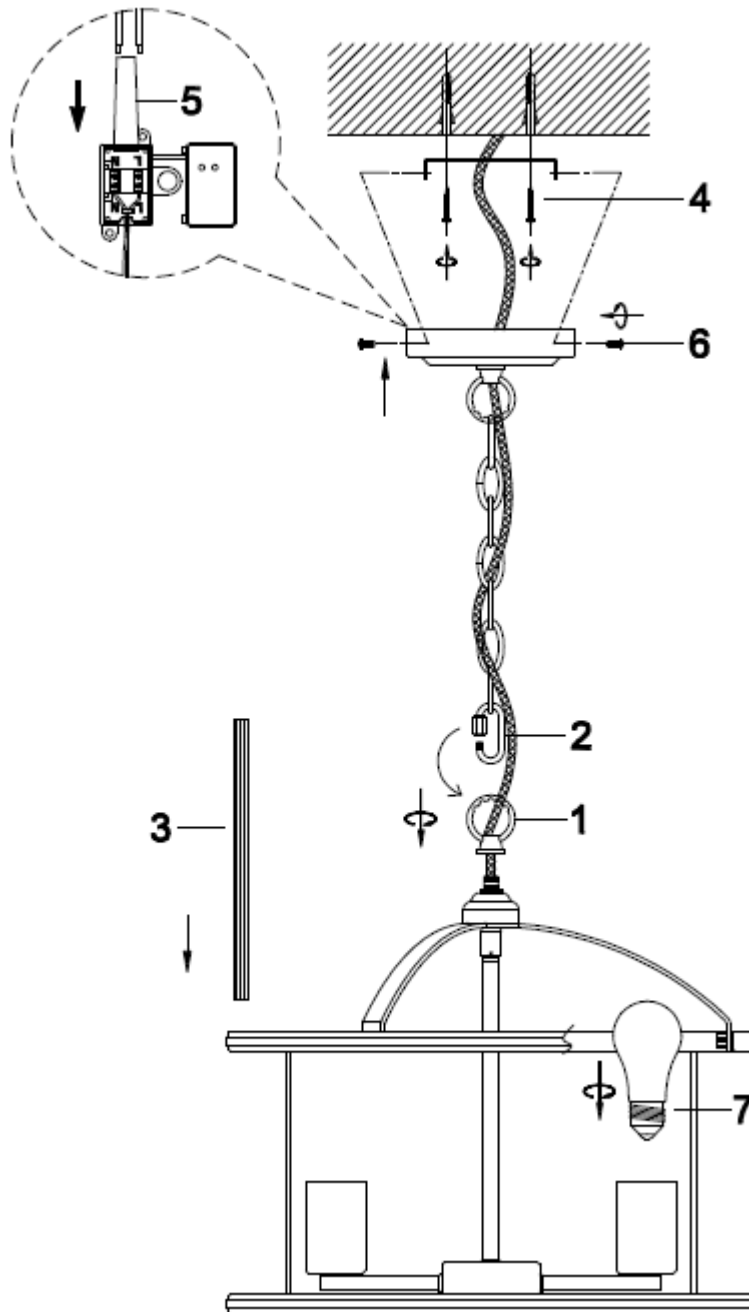

GENERAL INFORMATION

This fitting is designed for internal use only and must be fitted to a DRY SURFACE as any dampness in plaster or paint can damage the finish. **Do not use polish or abrasive cleaner - just a soft dry cloth.**